

# PENSILE GIREVOLE HITO

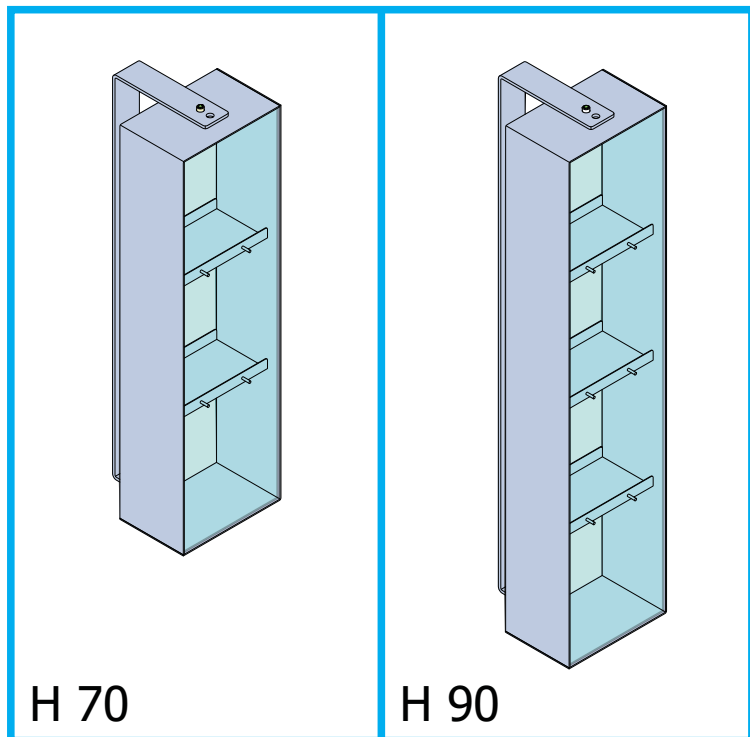

**IT INDICE**

1. FERRAMENTA .....	1
2. INSTALLAZIONE .....	2

**GB CONTENTS**

1. HARDWARE KIT .....	1
2. INSTALLATION .....	2





**D INHALTSVERZEICHNIS**

1. EISENWAREN-KIT .....	1
2. MONTAGE .....	2

**F INDEX**







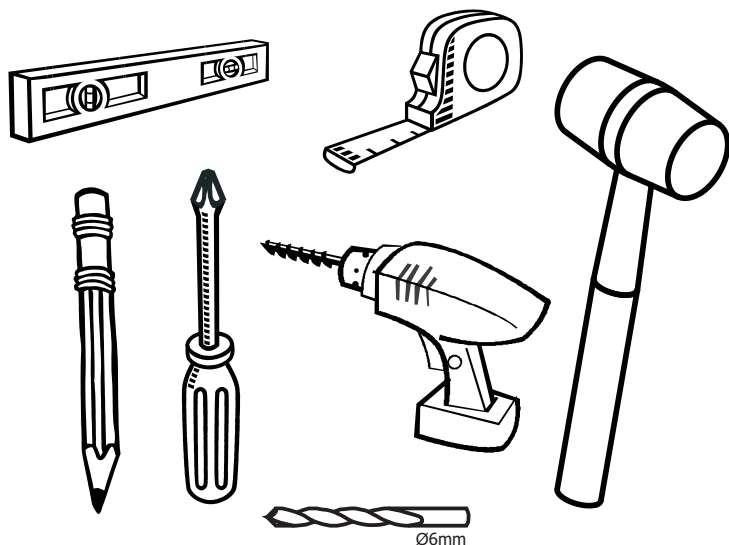

1. QUINCAILLERIE .....	1
2. INSTALLATION .....	2



- IT ATTENZIONE:**  
 - Verificare la condizione del supporto prima dell'installazione e di scegliere viti adeguate al supporto esistente. 
- GB ATTENTION:**  
 - Check the support condition before proceeding with the installation ; also choose adequate screws for the existing support. 
- D ACHTUNG:**  
 - Vor der Installation des Spiegels den Zustand überprüfen; wählen Sie angemessene Schrauben für bestehenden Halter aus. 
- F ATTENTION:**  
 - Vérifier les conditions du support avant l'installation et choisir les vis appropriées au support existant. 



**IT FERRAMENTA      GB HARDWARE KIT**  
**D EISENWAREN-KIT      F QUINCAILLERIE**

<b>F01</b>  N°2 Ø6x30	<b>F02</b>  N°2 Ø4,5x10	<b>F03</b>  N°2 Ø4,5x40	<b>F04</b>  N°2
<b>F05</b>  N°2	<b>F06</b>  N°1 Ø6,4x12	<b>F07</b>  N°1 M6x12	<b>F08</b>  N°1 M6F 8x15

